

aFRR optimisation system

AFRR & IN OPTIMISATION MATHEMATICAL DESCRIPTION FOR PUBLICATION

Valid from 05.08.2024

CONTENT

- INTRODUCTION _____ 3
- 1.0 POWER SYSTEM NETWORK _____ 4
- 2.0 MARKET MODEL FOR COMMON MERIT ORDER OPTIMISATION _____ 6
 - 2.1 Pre-process: calculation of target value for unsatisfied demand _____ 6
 - 2.2 Objective function _____ 7
 - 2.3 Priorization of demand satisfaction _____ 8
 - 2.4 Limitations of the optimisation variables _____ 8
 - 2.5 Demand satisfaction and offer activation _____ 8
 - 2.6 Handling of counter-activation and netting _____ 10
 - 2.7 Proportional distribution of unsatisfied demand _____ 10
 - 2.8 Congestion management based on net and directed profile limits _____ 12
- 3.0 MARKET MODELLING FOR IMBALANCE NETTING OPTIMISATION _____ 13
 - 3.1 Preprocess _____ 13
 - 3.2 Objective function _____ 13
 - 3.3 Deviation from target value for netting _____ 14
 - 3.4 Proportional distribution of deviation from target value for netting _____ 14
 - 3.5 Power Balance _____ 14
 - 3.6 Flow Balance and Sum of Corrections _____ 14
 - 3.7 Congestion Management _____ 14
- 4.0 LINKING OF THE TWO OPTIMISATION PROBLEMS _____ 15
- 5.0 MARKET MODELLING FOR PRICING OPTIMISATION _____ 16
 - 5.1 Determination of border congestion _____ 16
 - 5.2 Price targets _____ 19
 - 5.3 Objective function _____ 22
 - 5.4 Prevention of unforeseeably selected bids _____ 22
 - 5.5 Prevention of counterintuitive flows when activating in the same direction _____ 22
 - 5.6 Price Convergence _____ 23
- 6.0 APPENDIX _____ 24
 - 6.1 Mathematical Definitions _____ 24
 - 6.2 Mathematical formulations of objective functions _____ 27

Introduction

This document describes and specifies the algorithm used for the Activation Optimisation Function (AOF) of the aFRR Platform. It includes:

- Mathematical description of the aFRR Common Merit Order (CMO) optimisation problem;
- Mathematical description of the Imbalance Netting (IN) optimisation problem;
- Link between optimisation steps (optimisation sequence);
- Mathematical description of the pricing optimisation problem for aFRR.

A high-level scheme showing the interaction of the different functions of the aFRR-Platform with each other and with other processes is shown in the figure below.

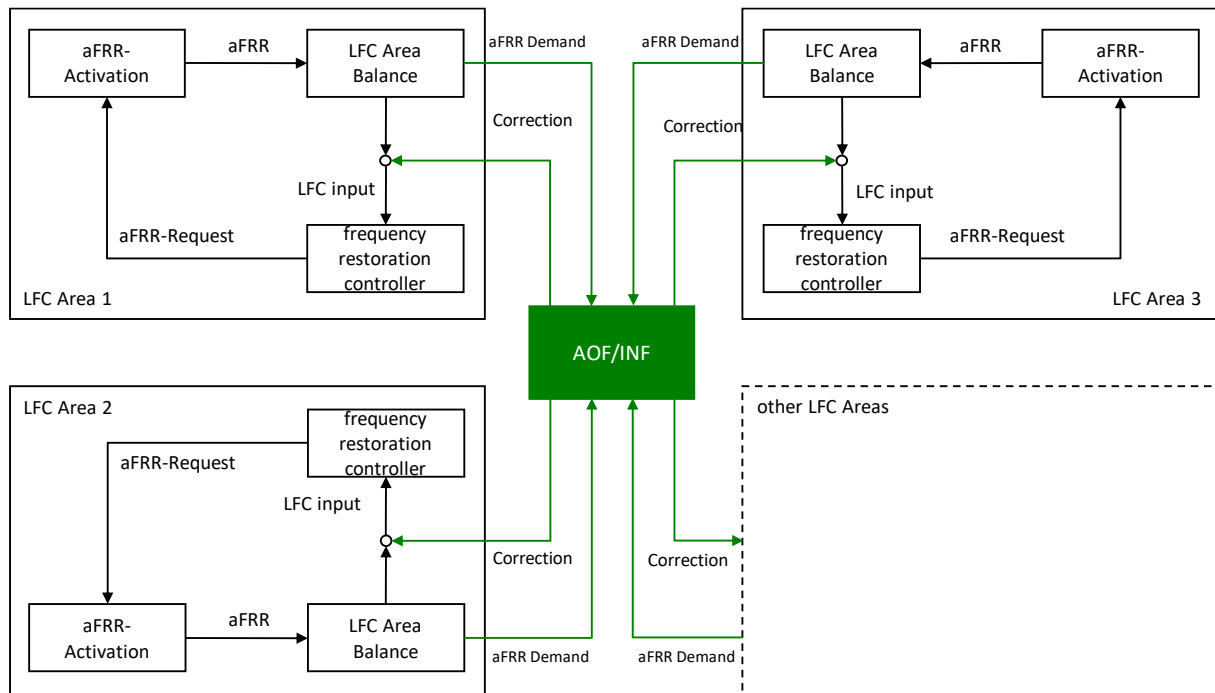

Figure 1 - High level design of interaction between AOF and LFC areas

The AOF is configured to run 4 second-optimisation cycles. Each cycle is composed of three steps (CMO, IN, CMO) whose linking is furtherly described in Chapter 4. In these steps netting of demands is performed (CMOs, IN) and bids are selected (only in CMOs). After the three steps, the pricing optimisation problem is solved to determine the marginal price for each LFC area. In the last part of the cycle a post process is carried out to determine the HVDC setpoint. The picture below summarizes one AOF cycle.

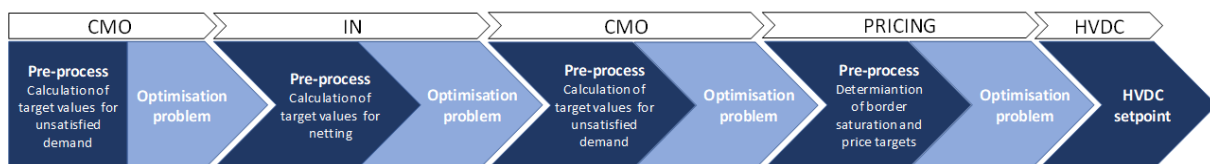

Figure 2 - AOF cycle

1.0 Power system network

The PICASSO Activation Optimization Function (AOF) optimizes the aFRR activation by maximizing the social welfare at European level taking into account the network topology and aFRR balancing energy bids.

The grid topology is modelled with *aFRR balancing borders* which are represented by constraints in the algorithm. These constraints limit the crossborder exchange of aFRR with the latest values of the so called ATCs (Available Transmission Capacity), which in turn are determined by previous markets and processes. aFRR balancing borders are bi-directional and have one ATC limit per direction. No losses are considered on aFRR balancing borders.

PICASSO AOF has the feature of estimating power flows. This approach is called flow-based. With this approach the network is modelled with Power Transfer Distribution Factors (PTDF) which is a Matrix derived from the network topology. Physical flows over an arbitrary corridor (AC network element or set of network elements in the AC grid) are estimated by the multiplication of the ex- and imports of each LFC area with the PTDF. This feature is currently used for monitoring reasons only but not constraining the results of the AOF.

Often aFRR balancing borders correspond to bidding zone borders. According to FG CACM (Framework Guidelines on Capacity Allocation and Congestion Management), a bidding zone is a network area within which market participants submit their bids. Bidding zones shall be defined by TSOs according to the principle of overall market efficiency and influence on physical flow conditions in third countries. This includes all economic, technical and legal aspects of relevance, such as security of system operation, socio economic welfare, liquidity, competition, network structure and topology, planned network reinforcement and re-dispatching costs.

There are two situations in which there can be a difference between aFRR balancing borders and bidding zone borders:

- When there are bidding zone borders inside an LFC area, these bidding zone borders do not correspond to an aFRR balancing border.
- When there are LFC area borders within a bidding zone, these are aFRR balancing borders that do not correspond to a bidding zone border.

In PICASSO, all bids and demands are considered on LFC area level. LFC areas are connected by aFRR balancing borders and are integrated in higher levels of hierarchy. Possible configurations are depicted in *Figure 3*.

The possible configurations include the following:

- A bidding zone may consist of one LFC block which consists of one LFC area (e.g. France);
- A bidding zone may consist of one LFC block which consists of more than one LFC areas (e.g. German LFC areas after the bidding zone split with AT in 2019);
- A bidding zone may consist of several LFC blocks and each of these LFC blocks may have consist of more than one LFC area (e.g. bidding zone of Germany and Austria before the bidding zone split in 2019);
- A LFC block may consist of one LFC area which includes several bidding zones (e.g. Italy, current Nordic configuration);
- A LFC block may consist of more than one LFC area where each LFC area equals one bidding zone (e.g. future Nordic system).

- An LFC Block consists of more than one bidding zone where each bidding zone includes more than one LFC Area (e.g., DE-DKW-LU LFC Block after DKW LFC Area separation June 2022).

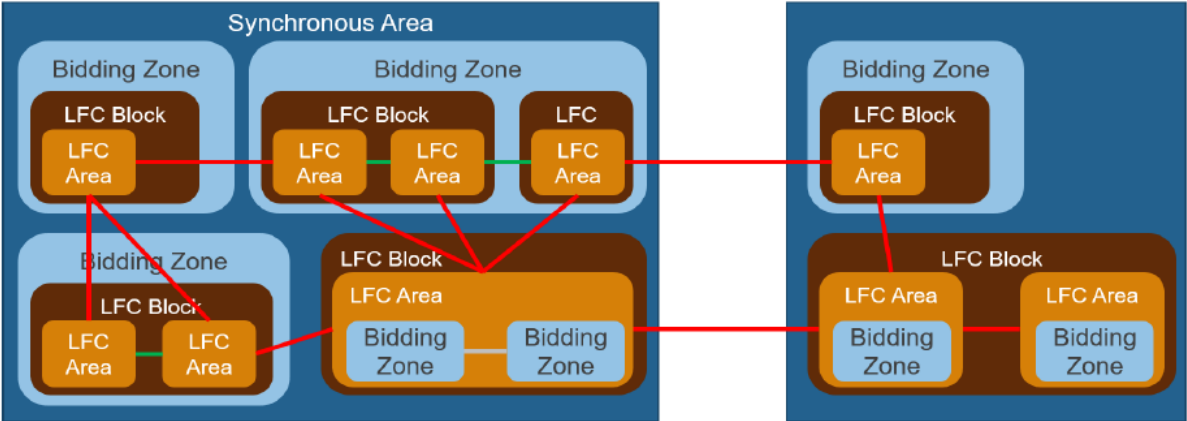

- aFRR balancing borders corresponding to bidding zone borders
- aFRR balancing borders within a bidding zone
- bidding zone borders within an LFC area

Figure 3 - Hierarchisation within PICASSO

2.0 Market Model for Common Merit Order Optimisation

2.1 Pre-process: calculation of target value for unsatisfied demand

In the optimization region¹, full access to CMOL is allowed, meaning that each participating TSO is allowed to request an activation of a higher amount of aFRR than that submitted to the CMOL. However, such full access to CMOL must not block the local access of each participating TSO to the aFRR volumes submitted to the platform from its LFC areas, or otherwise obtained through the common procurement and/or exchange or sharing of reserves.

In order to guarantee full access to CMOL and priority access to local volumes², it is necessary to introduce a way to distribute the unsatisfied aFRR demand among LFC areas. To handle prior access to reserves, target values for unsatisfied demand are determined in a pre-processing step on the following levels:

- LFC area,
- region (control area, LFC block, region with sharing / common procurement of aFRR capacity, synchronous area).

The optimisation algorithm considers the hierarchisation of LFC areas. The different configurations of common procurement and/or exchange or sharing of reserves within/or between LFC blocks is always respected from a system operation security perspective.

In the algorithm, this basically means that when all demands are satisfied, no specific rules (additionally to economic surplus maximization and cross border flows minimization) apply. However, in case of unsatisfied demands:

- The LFC areas which form one control area have priority access to the standard aFRR balancing energy product bids submitted by the respective TSO and transmission capacity inside the control area pursuant Article 29 (12) of the EBGL, which gives each TSO access to the volumes he has submitted.
- The LFC areas which form one LFC block and perform common dimensioning have priority access to the standard aFRR balancing energy bids and available cross-border capacity inside the LFC block.
- The TSOs procuring a part of their balancing capacity outside of their scheduling areas pursuant to Article 33 of the EBGL, will have priority access to the procured volume. The TSOs sharing aFRR reserves pursuant to Article 168 or Article 177 of the SOGL shall have priority access to the shared volume in case of unsatisfied demand.

The available aFRR of a LFC area for each direction is obtained through the algebraic sum of the submitted volume from the local MOL minus part of all volumes of this LFC area which are possibly shared in a sharing region, if any. Additionally, volume which is exchanged between LFC areas is considered.

The available aFRR of any region is the sum of the available aFRR of the concerned LFC areas plus the shared aFRR volume within this region. A region is defined by groups of LFC areas or groups of regions in accordance to exchange and sharing of reserves.

¹ The optimization region is determined considering all of the LFC areas which participate to the relevant optimization step (see Introduction and Chapter 4).

² A region that guarantees priority access to its local volumes to all of the LFC areas that belong to that region, is called priority region.

The target value for the unsatisfied demand of a LFC area is calculated by subtracting the available aFRR from the demand.

The target value of unsatisfied demand of a region set as a priority region (for instance in case of common dimensioning) is calculated in a similar way, considering the sum of all demands. This means that a priority region will only have a target value for unsatisfied demand greater than zero if the sum of all bids in this region is not sufficient to cover its demand.

In contrast, the target value for unsatisfied demand of non-priority-regions is determined by the largest unsatisfied demand of subordinate LFC areas or subregions. This means that a non-priority region will have a target value for unsatisfied demand greater than zero if any of its LFC areas have an unsatisfied demand, or the sum of all bids plus the regionally shared volume is not sufficient to cover the LFC area demand. Non-priority setting is applied for instance to regions having sharing agreement giving priority access to the shared volume only.

2.2 Objective function

The main objectives of the optimisation algorithm are:

- (a) Maximise satisfaction of the aFRR demand of individual LFC areas (see priority 1 below);
- (b) Maximise the economic surplus (see priority 2 below);
- (c) Minimise the amount of the automatic frequency restoration power interchange on each aFRR balancing border (see priority 4 below).

The detailed list of all the objectives which are optimized is reported in the following table. Please note that they are sorted in priority order.

Priority	Objective
1	Maximize satisfaction of the aFRR demand of individual LFC areas
2	Maximise the economic surplus
3	Minimize the deviation from the proportional distribution of relative deviation from the target values for unsatisfied demand
4	Minimize the amount of cross-zonal capacity usage
5	Equal distribution of flows over parallel trading paths
6	Minimize approximated physical flows
7	Minimize the deviation of cross-zonal-flows from their target value
8	Minimize the deviation of physical flows from their target value

Table 1: Objectives of the CMO optimisation problem

The mathematical formulation of the objective function of CMO is described in the appendix.

As mentioned in the introduction, physical flow limits will not constrain the result, so priority 6 and 8 will be disabled.

In the following paragraphs, specific details and constraints are listed and described. All constraints apply for each optimization cycle.

2.3 Priorization of demand satisfaction

LFC areas are divided into two groups:

- 1) LFC areas or LFC blocks with an aFRR band that is sufficient to satisfy their local demand will have a target value for unsatisfied demand equal to zero. These areas have prior access to aFRR capacity, hence their demand has a higher weight. This also applies to LFC areas which are part of a priority region that has a target value for unsatisfied demand equal to zero.
- 2) The other group are LFC areas without prior access, hence they have a lower weight.

2.4 Limitations of the optimisation variables

The following constraints are considered in CMO optimization.

- The selection of each bid must be lower or equal than the offered volume.
- The satisfied demand must be lower or equal than the demand of the respective LFC area.
- The unsatisfied demand must be lower or equal than the demand of the respective LFC area.
- The cross-zonal flow is limited by the available cross-zonal-capacity. If net and/or directed profile limits are used, the cross-zonal flow is also limited by such profiles.
- The estimated physical power flow on each corridor is limited by the available physical transmission capacity.
- The sum of all cross-zonal flows of one LFC area equals the net position of the LFC area.
- The sum of all correction values equals zero.

2.5 Demand satisfaction and offer activation

For each LFC area, the aFRR interchange (sum of cross-border flows) must equal the difference between selected bids and satisfied demand.

In order to manage counter-activations in the algorithm, negative demands and upward activations are split into two variables. With reference to the figure below, one variable is used to express the part related to satisfaction of positive demands ("SD"), and one variable is related to the matching of downward offers ("MO"). There is no need to define the same variables for negative demands and the matching of upward offers due to symmetry.

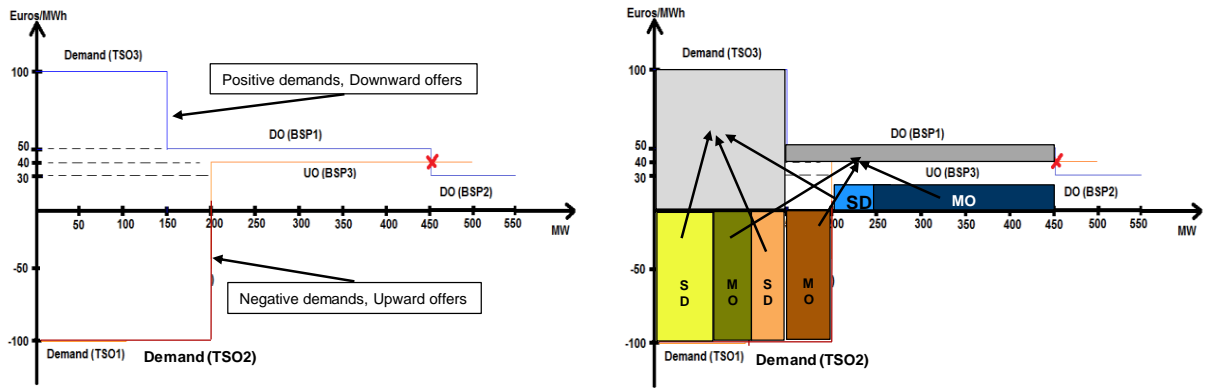

Figure 4: Splitting of negative demands and upward offers into two variables

Considering the split of such variables:

- The activation of each offer is the sum of activated offers for satisfying demand and for matching offers;
- The aFRR demand of each LFC area is either satisfied by netting or from offer activation;
- The total flow on each border is either due to flow for demand satisfaction or for offer matching.

The following picture exemplifies the application of the abovementioned boundary conditions, if counteractivations are fully allowed in the AOF:

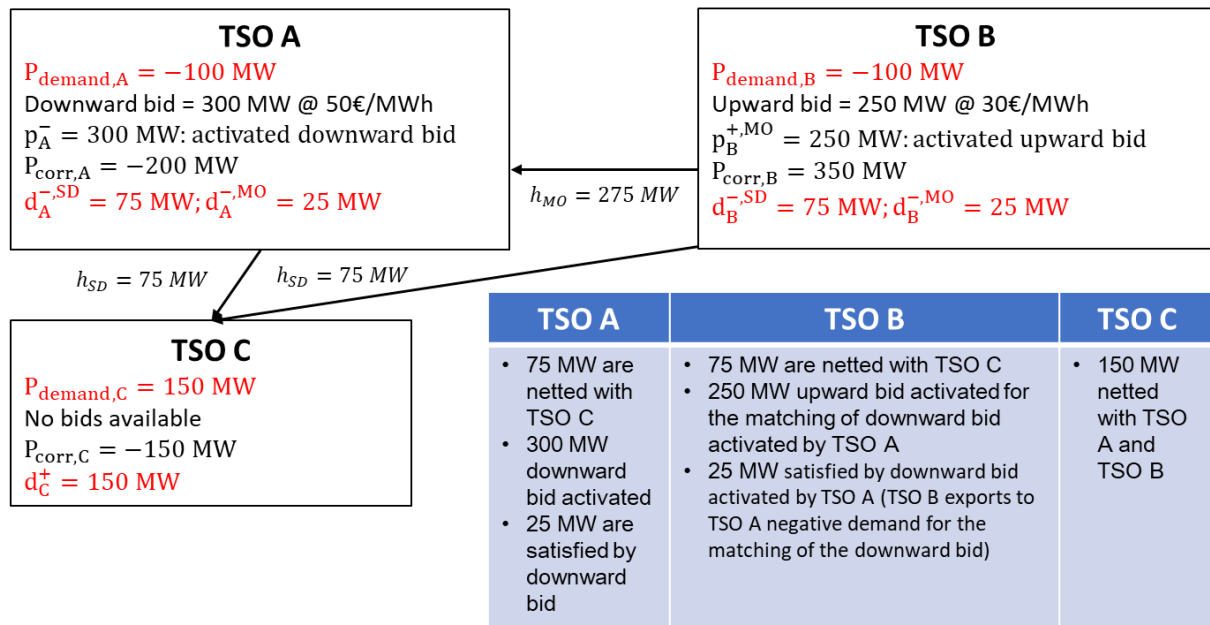

Figure 5: Example of satisfaction of demand and activation of offers with full allowance of counter-activations. In the picture, P_{demand} is the demand of each LFC area, p^- is the activated downward bid, $p^{+,MO}$ the activated upward bid to match negative offers, $d^{-,SD}$ and $d^{-,MO}$ are negative demands satisfied by netting of offers, respectively. d^+ is the satisfied positive demand and P_{corr} is the correction value.

In contrast, the figure below shows the same situation but with full avoidance of counter activation.

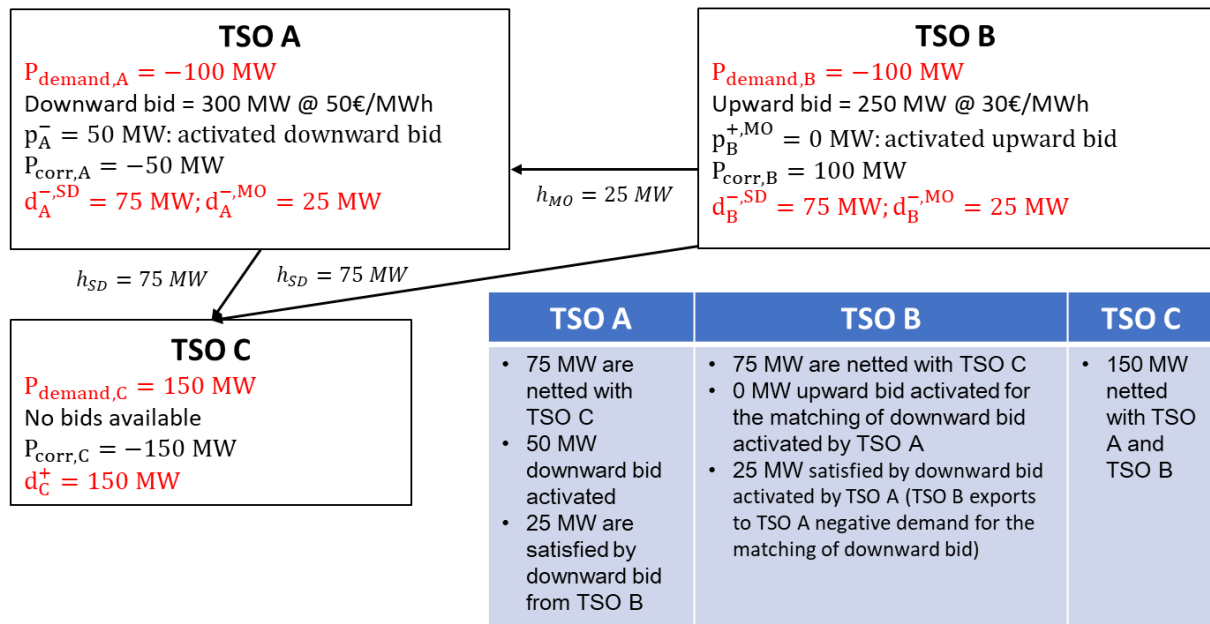

Figure 6: Example of full avoidance of counter activation

2.6 Handling of counter-activation and netting

The algorithm as described in the previous paragraphs will lead to the maximisation of social welfare. This is achieved by fully allowing for counter-activations and avoiding netting of demand if either is optimal.

Counter-activations may in principle occur in case of reverse pricing, i.e. the price of a bid for upward activation is lower than the price of a bid for downward activation. Price reversal can take place both within a single LFC area or between LFC areas, for several reasons including inefficiencies in bidding strategies and price differences in other markets previous to the balancing market due to congestions. The realisation of these price reversed counter-activations depends on whether they are located within an LFC area or between LFC areas, and whether there is available transmission capacity to accommodate them between the LFC areas. Most TSOs currently can only activate bids in one direction within one LFC area, hence counter activations within a LFC area would be most of the time not realised.

TSOs decided not to allow counter-activations in the aFRR-Platform, with the main reason being focused on the dynamic effects that could cause counter activations to create additional imbalance. The increased complexity induced in the algorithm if counter-activations should be allowed has also played a role in the decision. The effect of not allowing counter-activations will be monitored by TSOs.

Not allowing counter-activation implies that all possible netting will be performed, regardless of the bid prices.

2.7 Proportional distribution of unsatisfied demand

Target values for unsatisfied demand are calculated in the pre-process (see Chapter 3.1) of each CMO step. During the optimization, the unsatisfied demand is then distributed among LFC areas proportionally to their target values. Furthermore, in case of congestions the optimisation result may deviate from the proportional distribution. For fairness reasons the relative deviations from the proportional distribution, i.e. the deviations divided by the respective target value, shall be distributed equally to the participating LFC areas.

In case of a hierarchical setup of regions (LFC areas, control areas, LFC blocks, sharing regions or synchronous areas), the fairness constraints are applied for each group of LFC area or regions that share the same parent region. When applied to regions, the aggregated unsatisfied demand is considered in the constraints:

Some examples of distribution of unsatisfied demand are reported below. The first example represents a simple configuration of four LFC areas without congestions, where the overall unsatisfied demand is distributed proportionally to target values.

Example 1					
LFC Area	A	B	C	D	TOTAL
Parent Region	-	-	-	-	-
Demand [MW]	150	150	50	100	450
Upward bids [MW]	100	50	100	100	350
Target Value for unsatisfied demand [MW]	50	100	0	0	-
Correction value [MW]	-16.7	-33.3	50	0	0
Unsatisfied demand [MW]	33.3	66.7	0	0	100

Figure 7 - Distribution of unsatisfied demand in simple LFC area configuration

The second example describes a hierarchical configuration without congestions. The overall unsatisfied demand is firstly split between Regions X and Y proportionally to their target values. Then, the regional unsatisfied demand is distributed to single LFC areas proportionally to their local target values.

Example 2 – Hierarchical optimisation region						
LFC Area	A	B	C	D	E	TOTAL
Parent Region	X		Y		-	-
Demand [MW]	200	200	250	250	0	900
Upward bids [MW]	100	100	50	150	200	600
Target Value for unsatisfied demand LFC [MW]	100	100	200	100	0	-
Target Value for unsatisfied demand Region [MW]	200		300		-	-
Correction Value [MW]	-40	-40	-80	-40	200	0
Unsatisfied demand [MW]	60	60	120	60	0	300

Figure 8 - Distribution of unsatisfied demand in hierarchical optimisation region

The third example describes the same hierarchical configuration of example 2 but considering congestions. In this case, due to the congestion of one border, proportional distribution of unsatisfied demand cannot be achieved in Region X. The optimisation results are shown in the table below.

Example 3 – Hierarchical optimisation region with congestions						
LFC Area	A	B	C	D	E	TOTAL
Parent Region	X		Y		-	-
Demand [MW]	200	200	250	250	0	900
CZCL	[-20; 20]	No limit	No limit	No limit	No limit	-
Upward bids [MW]	100	100	50	150	200	600
Target Value for unsatisfied demand LFC [MW]	100	100	200	100	0	-
Target Value for unsatisfied demand Region [MW]	200		300		-	-
Correction Value [MW]	-20	-60	-80	-40	200	0
Unsatisfied demand [MW]	80	40	120	60	0	300

Figure 9 - Distribution of unsatisfied demand considering congestions

2.8 Congestion management based on net and directed profile limits

As stated in Chapter 2.4, cross-zonal flows are limited by cross-zonal capacity limits. Furthermore, cross-border flows can be limited by other kind of constraints, namely the net and or directed profile limits. Such constraints limit the flow on a predefined set of borders – e.g. all the borders surrounding a LFC area.

A net profile can be used to limit the net position of a region, without blocking transit flows through the region. In contrast, a directed profile limits the sum of the flows in a given direction (import or export). They effectively limit transit flows.

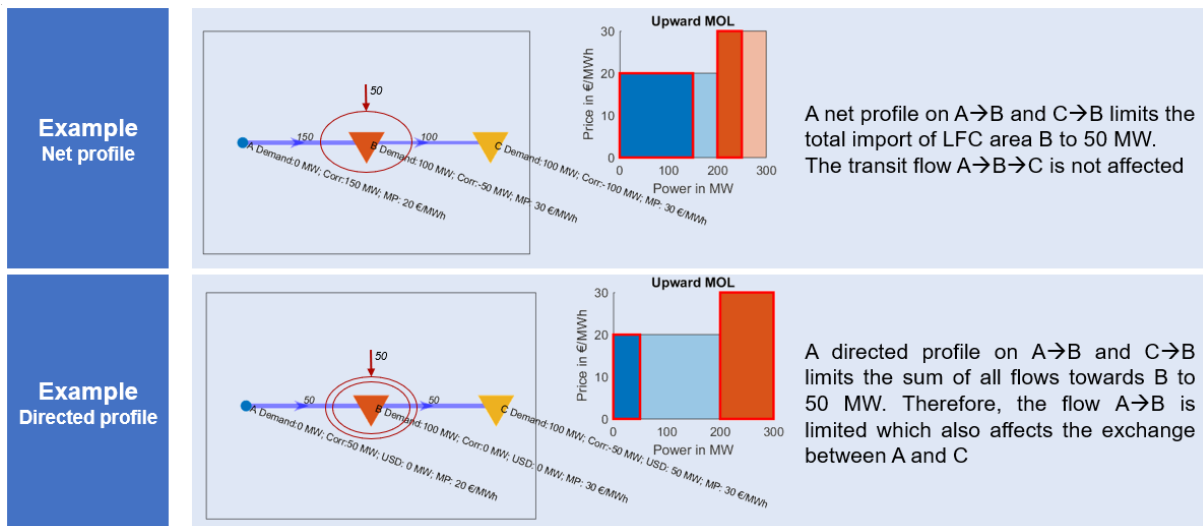

Figure 10 - Example of net and directed profiles. In the example Corr is the correction value, USD stands for unsatisfied demand, MP is the marginal price.

In addition, the AOF is configured to manage limitations imposed on physical flows over an arbitrary corridor which is an AC network element or set of network elements in the AC grid.

3.0 Market Modelling for Imbalance Netting Optimisation

3.1 Preprocess

For conducting the Imbalance Netting (IN) optimisation, a pre-process is necessary to determine the target values for the netting, which are calculated as described in this paragraph. Therefore the net aFRR demand over all LFC areas participating in the IN is calculated.

For each LFC area participating in the IN whose aFRR demand is opposite to the net aFRR demand, the target value is set equal to the negative of its aFRR demand.

For each LFC area participating in the IN with aFRR demand in the same direction of the net aFRR demand:

- In case of positive net aFRR demand, the target value for all LFC areas with positive aFRR demand is set equal to the negative proportion of its own demand, compared to the total positive aFRR demand, times the total negative aFRR demand for IN problem.
- In case of negative net aFRR demand, the target value for all LFC areas with negative aFRR demand is set equal to the negative proportion of its own demand, compared to the total negative aFRR demand, times the total positive aFRR demand for IN problem.

3.2 Objective function

The objective function of the IN consists of nine parts with different priorities. Table 2 shows the priority order of the individual objectives.

Priority	Objective
1	Minimize the deviation from the target value of netting
2	Minimize unsatisfied aFRR demand of individual LFC areas
3	Minimize the deviation from the proportional distribution of deviation from the target value of netting
4	Minimize the absolute value of the correction values
5	Minimize the amount of cross-zonal capacity usage
6	Equal distribution of flows over parallel trading paths
7	Minimize approximated physical flows
8	Minimize the deviation of cross-zonal-flows from their target value
9	Minimize the deviation of physical flows from their target value

Table 2: Objectives of the IN optimisation problem

Further details on the mathematical equation of the optimization function from the IN problem are given in the appendix.

As mentioned in the introduction, physical flow limits will not constrain the result, so priority 7 and 9 will be disabled.

In the following paragraphs, specific details and constraints are listed and described. All constraints apply for each optimization cycle.

3.3 Deviation from target value for netting

The target values for netting are calculated in a preprocessing step (see chapter 3.1). The deviations from the target values are then minimized.

3.4 Proportional distribution of deviation from target value for netting

In case of congestions the target values cannot be reached. For fairness reasons, the relative deviations (deviations divided by the respective target value) shall be distributed equally to the participating LFC areas.

This boundary condition is only built for pairs of LFC areas participating to the IN, whose target values have the same sign. For numerical reasons, LFC areas with very small target values are excluded.

3.5 Power Balance

The sum of correction and unsatisfied (unnetted) demand must be equal to the demand of each LFC area participating in the IN.

3.6 Flow Balance and Sum of Corrections

The sum of all cross-zonal flows of one LFC area equals the net position of one LFC area. The sum of all correction values equals zero. Both conditions also hold for the CMO optimization (see Chapter 2.4). The only difference is that the boundary conditions apply to LFC areas participating to the IN.

3.7 Congestion Management

For the Congestion Management of the Imbalance Netting the same boundary conditions are used as for the CMO optimisation (see section 2.8). The only difference is that the boundary conditions apply to LFC areas participating to the IN.

4.0 Linking of the two Optimisation Problems

According to aFRR Implementation Framework Article 11, the two optimisation problems, namely CMO optimisation and IN optimisation, shall be performed respecting the following sequence in each optimisation cycle:

1. Step n°1 : CMO optimisation in the aFRR optimisation region, which includes the LFC areas participating to both aFRR process (aFRP) and IN process (INP), pursuant IF Article 2.1.(d).
2. Step n°2 : IN optimisation for the LFC areas participating to IN process, considering the remaining cross-zonal capacity after the first step.
3. Step n°3 : CMO optimisation for the LFC areas participating to aFRR process, considering the remaining cross-zonal capacity after the second step.

The optimisation sequence is outlined in Figure 11.

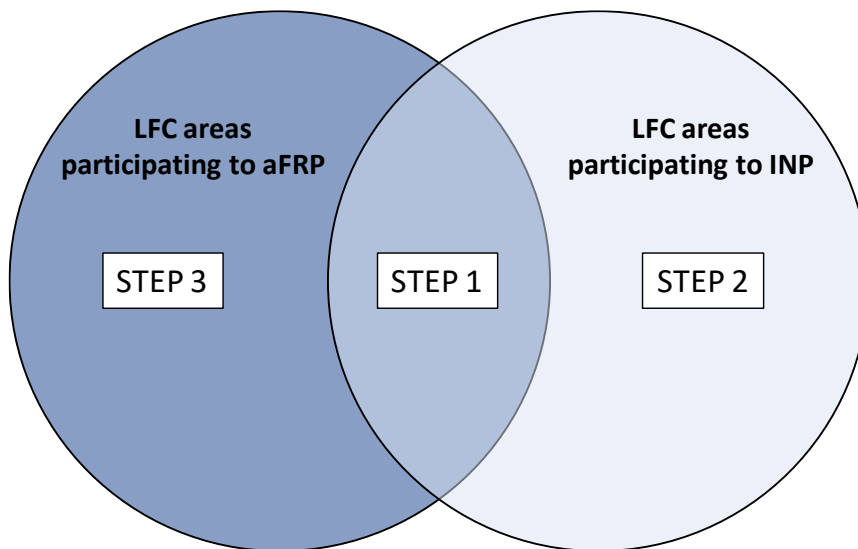

Figure 11 - Optimisation sequence of each cycle

To provide a high degree of flexibility, the aFRR Platform has been designed to run any sequence composed by CMO and IN optimisation problems.

In general, inputs for the subsequent optimisation step have to be derived from the outputs of the previous step, matching them with the information about the participation status of each LFC area and the relevant borders to those steps.

The remaining aFRR demand of the subsequent optimisation problem is derived by adding the calculated correction value to the aFRR demand of the previous optimisation problem.

In the same way limits are adjusted for the subsequent optimisation problem.

5.0 Market Modelling for Pricing Optimisation

The previous chapters treated the optimisation of power flows observing the constraints and taking into account the costs of selected bids. This chapter describes how the final crossborder marginal prices (CBMP) are determined. These final CBMP serve as price signal for market participants meaning that the CBMP shall convey the value of delivered and consumed balancing energy. Also, the CBMP is used for the TSO-TSO settlement. The CBMP is determined for each AOF Optimization cycle (4 s).

In PICASSO, prices are considered on LFC area level. Uncongested regions consist of LFC areas that are connected by uncongested borders. So an uncongested region is at minimum formed by a single LFC area, when all of its borders are congested, or it is at maximum formed by all LFC areas, when for example there is no congestion at all.

According to the “Methodology for pricing balancing energy and cross-zonal capacity used for the exchange of balancing energy or operating the imbalance netting process” (in accordance with Article 30(1) EBGL) for each aFRR Market Time Unit (MTU) a single CBMP shall be determined for each uncongested region.

In the current PICASSO design with full avoidance of counter-activations, bids can only be selected either in upward direction or downward direction but never in both directions within an uncongested region and within one MTU. Furthermore, two situations can occur:

- Bids are actually selected in an uncongested region. In this case the CBMP is the price for the last (i.e. the most expensive upward or the cheapest downward bid) selected bid.
- No bids are selected in an uncongested region. This can happen when the demand is fully covered by bids from other uncongested regions or when full netting occurs. In this case, the CBMP needs to be formed by the price for the next bid that could hypothetically be selected.

In order to achieve the before-mentioned requirement to determine a CBMP for each LFC area, an additional optimisation problem, which takes the results of the last optimisation³ run in the sequence as input, is solved.

The pricing optimisation problem consists of the following steps:

1. Determination of border congestion (first preprocess, c.f. chapter 5.1);
2. Determination of price targets and uncongested regions (second preprocess, c.f. chapter 5.2);
3. Determination of the final CBMP (the actual optimization, c.f. chapter 5.3).

In the following, only objects (areas, borders, corridors, profiles) are considered, which are part of this last optimisation step.

5.1 Determination of border congestion

This chapter describes the process of determining congested borders. Border congestion is given, when it is not possible to transfer additional balancing energy from one LFC area to another due to a capacity limit. The limitation may be caused by ATC limits, physical flow limits on corridors or profile limits. Furthermore, a limitation may be applied in one direction or in both directions.

When solving the CMO/flow problem all constraints due to aFRR balancing border limits, physical flow limits or profile limits are respected. Congestion is closely related to the saturation of these constraints.

³ We assume the last step in the sequence to be a CMO optimisation. Otherwise, the saturation of borders, corridors and profiles may be caused by the IN results.

Saturation is a measure of how close the constraints are to being binding. One way to measure saturation is the difference between limits and optimisation variable values of the result of the CMO optimisation. If this difference is sufficiently small, saturation is given, indicating congestion.

In general, a border (AC or HVDC) is deemed saturated when either the CZC limit, a profile limit (either net or direct profile), or a physical flow limit, involving the border, is saturated within a tolerance. In contrast, a border (AC or HVDC) is deemed saturated opposite of the flow when either a net profile limit or a physical flow limit involving the border is saturated in the opposite direction of the border-flow within a tolerance.

SATURATION OF A BORDER DUE TO NET PROFILE LIMITS

The saturation of a border due to profile limits is determined by evaluating the saturation of profile limits. In order to enhance a comprehension confer Figure 12:

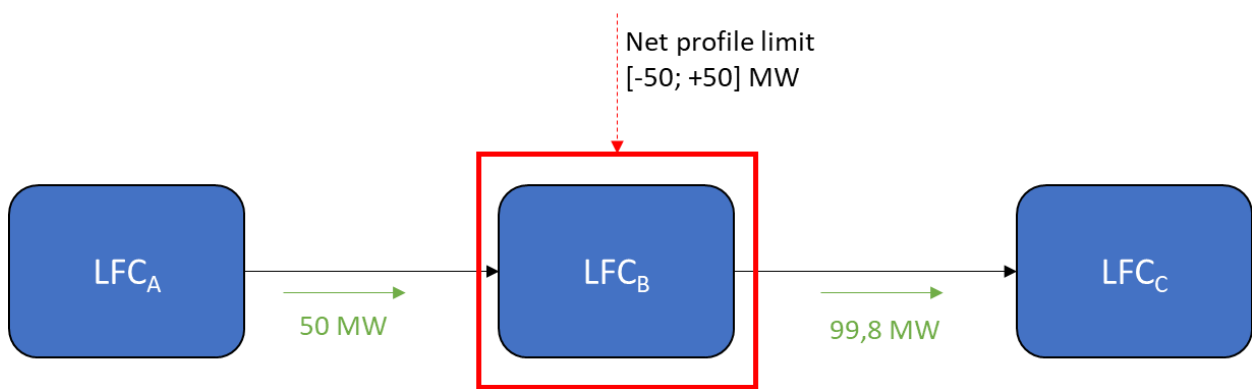

Figure 12 – Saturation of borders: example with saturation opposite of the flow

In this example a net profile around LFC area B is given with a maximum of 50 MW allowed to flow towards it and 50 MW to flow away from it respectively. The CMO optimization determined the border so that in sum 49,8 MW are flowing away from the profile. Now, considering a tolerance of $\delta = 0.5$, the border h_{AB} is deemed saturated opposite to the flow because the flow cannot be decreased due to the lower net profile limit. In comparison, the flow on the border h_{BC} cannot be increased due to the upper net profile limit so it is deemed saturated in flow direction.

SATURATION OF A BORDER DUE TO DIRECTED PROFILE LIMITS

This section describes the determination of the set of borders saturated due to a directed profile limit. In contrast to netted profiles, directed profile limits consider all flows in the same direction without any netting. This is exemplified in Figure 13: The border h_{AB} is defined towards the profile and is counting for the upper limit of the profile, which is 50 MW too. It follows, that the profile is saturated by the border flow h_{AB} , which is therefore deemed saturated. Note that the flow h_{BC} does not affect the *upper* limit of the profile, since it is pointing away from the directed profile.

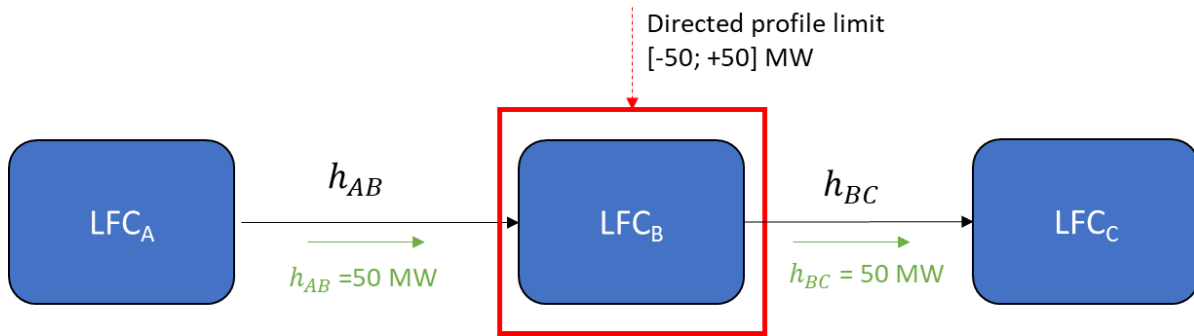

Figure 13: Example of a saturation of a border in case of directed profiles.

In case of directed profile limits, there is no saturation opposite to the flow.

SATURATION OF A BORDER DUE TO PHYSICAL FLOW LIMITS

As stated in the introduction physical flow limits do not constrain the results. Nevertheless the concept is explained in the following.

Physical flow limits are applicable to the usage of the flow-based method for calculating border flows. Therefore borderflows are estimated. Border saturation due to physical flow limits (resp. to corridors) is therefore determined by evaluating the saturation of the physical flow limits on corridors.

Figure 14 illustrates an example of the application of physical flow limits:

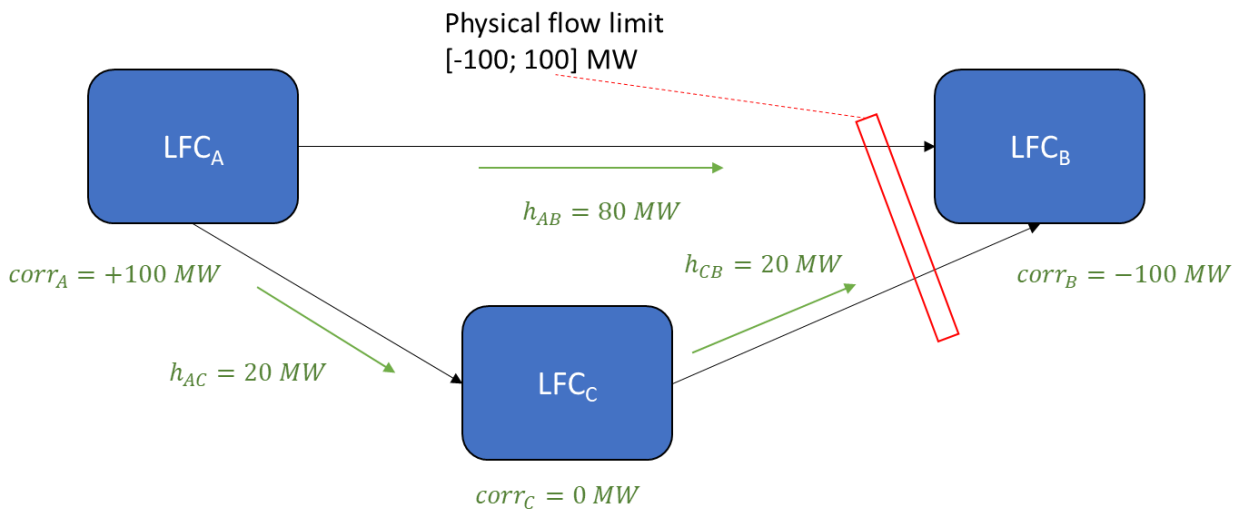

Figure 14: Example for physical flow limits

In the example given, there is a LFC area A with a correction value/net position of 100 MW, a LFC area B with a correction value of -100 MW and LFC area C with a correction value of 0 MW. The physical corridor considered in this example consists of the borders h_{AB} and h_{CB} . If the PTDF factor of LFC area A is bigger than the one of LFC area B, an increase of the net position in area A causes additional flows on the corridor. It follows, that both borders comprising the corridor are considered saturated in the direction of the flow.

5.2 Price targets

As described in the introduction, prices are to be derived from selected bids, possibly selected bids and depending on border saturation (i.e. congestions) and depending on the setpoint for automatic FRR activation.

The following definitions of sets of connected LFC areas are taken into account. The example network shown in Figure 15 will be used to illustrate each concept.

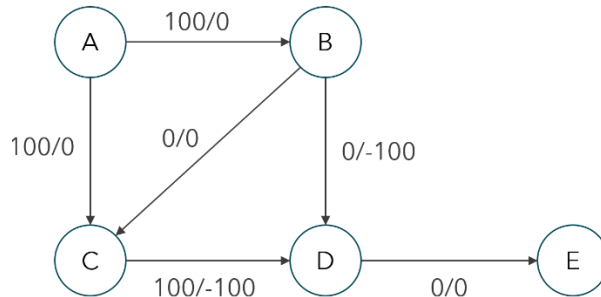

Figure 15: Example network. The capacities in positive/negative direction are displayed next to each border

UNCONGESTED REGIONS

An uncongested region is a maximal set of LFC areas which are connected through non-saturated borders.

In the example of Figure 16, only one border (C-D) has no limitations, thus C and D form an uncongested region and each of A, B and E form one uncongested region..

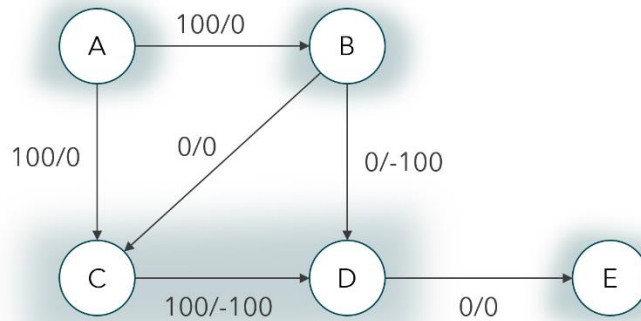

Figure 16: Example for Uncongested Regions. The capacities in positive/negative direction are displayed next to each border

AVAILABILITY REGIONS

Availability regions are sets of LFC areas respective to a given LFC area i . A LFC area j is contained in the set $I_{ar,i}^+$, if there exists a border path between i and j that is not congested in the direction of the hypothetical flow that would result if a positive bid in j was selected for LFC area i . Equivalently, j is contained in $I_{ar,i}^-$, if there exists a border path between i and j that is not congested in the direction of the hypothetical flow that would result if a negative bid in j was selected for LFC area i .

The availability regions for the LFC areas in the example are given in Figure 17. Graphically shown in Figure 17 are the availability regions of C, which are equal to those of D.

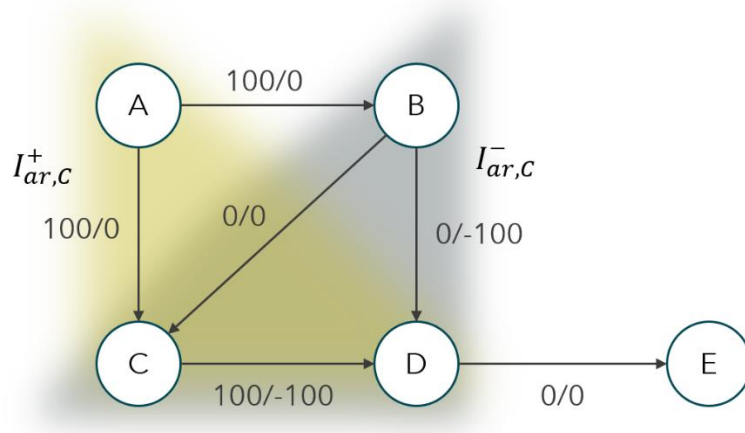

Figure 17: Availability Region of C (example network), $I_{ar,C}^+$ ($= I_{ar,D}^+$) in yellow, $I_{ar,C}^-$ ($= I_{ar,D}^-$) in grey

A positive/negative bid is considered as available for LFC area i if it is

- not fully selected and
- connected to a LFC area in $I_{ar,i}^+$ / $I_{ar,i}^-$.

COUPLED REGIONS

Each coupled region is a maximal set of LFC areas which are connected through borders with non-zero limits in at least one direction.

In Figure 18 the coupled regions of the example network are shown.

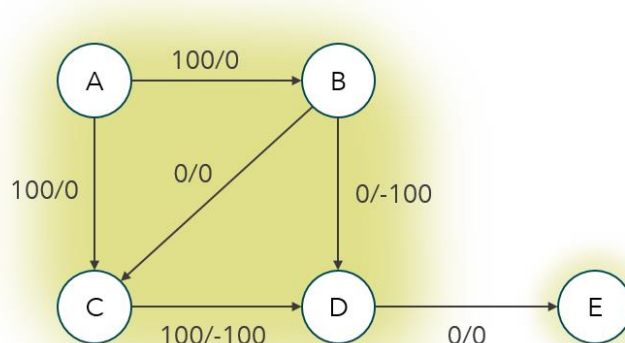

Figure 18: Coupled regions (example network)

PRICE TARGET DETERMINATION

In a preprocess, price targets are determined for each LFC area. The goal of this process is to define at least one price target per LFC area in each uncongested region. This is done in three steps.

First, the uncongested regions are scanned for selected bids. Second, as a fallback, the potentially reachable bids in the availability regions are taken in account. Third, as second fallback, bids from the coupled regions are used as basis for price targets.

1. Due to the disabling of counteractivation, in each LFC area either positive or negative bids are selected⁴.

For LFC areas with selected upward bids, price targets are determined as minimum of (i) the bid price in the local merit order list for positive aFRR corresponding to the setpoint for automatic FRR activation in the positive direction and (ii) the bid price of the bid corresponding to the volume of positive bids selected by the AOF in the local merit order list.

For LFC areas with selected downward bids, price targets are determined as maximum of (i) the bid price in the local merit order list for negative aFRR corresponding to the setpoint for automatic FRR activation in the negative direction and (ii) the bid price of the bid corresponding to the volume of negative bids selected by the AOF in the local merit order list.

The price target of the LFC area is equal to the middle point between the lowest positive and highest negative available standard aFRR balancing energy product bids in the following cases:

- the aFRR AOF selects no positive or negative aFRR balancing energy product bids in the respective uncongested area
- the aFRR AOF selects positive aFRR balancing energy product bids in the respective uncongested area while there are no LFC area setpoints for automatic FRR activation within the respective uncongested area in the positive direction
- the aFRR AOF selects negative aFRR balancing energy product bids in the respective uncongested area while there are no LFC area setpoints for automatic FRR activation within the respective uncongested area in the negative direction

In the following cases no price target is determined:

- In case no bids are selected by the AOF in a LFC area, but bids are selected by the AOF in the respective uncongested area, there is no price target in that LFC area.
- In case either no positive or no negative bid is connected to any LFC area in an uncongested region, this step provides no price target for the LFC areas of the uncongested region.

2. In case the previous rules set no price target to any LFC area in one coupled region I_{cr} , the price targets of all LFC areas of this coupled region are calculated in the following way:
 - In case upward and downward bids are connected to any LFC area of the coupled region, the price target is the mid-point between the lowest price of all upward bids and the highest price of all downward bids.
 - In case only upward bids are connected to any LFC area of the coupled region, the price target is the lowest price of all upward bids.
 - In case only downward bids are connected to any LFC area of the coupled region, the price target is the highest price of all downward bids.
3. In case no bids are connected to any LFC area of the coupled region, the price target is 0.

⁴ Moreover, this holds indeed for uncongested regions.

5.3 Objective function

The objective function of the pricing optimisation problem aims at minimizing the difference of the price to the price targets and the price differences between couples of LFC areas. The mathematical definition of the objective function is given in the appendix.

The constraints for the pricing optimisation are listed and described in the following.

5.4 Prevention of unforeseeably selected bids

The price of each LFC area must be greater than or equal to the highest price of upward selected bids and lower than or equal to the lowest price of downward selected bids.

5.5 Prevention of counterintuitive flows when activating in the same direction

Due to network constraints and netting of demands scenarios could occur where aFRR energy would flow from LFC area with a higher CBMP to one with a lower price, which is called a counterintuitive flow.

The PICASSO pricing prevents counterintuitive flows by adjusting prices. In order to achieve this, the following rule is applied: If in two LFC areas, which are connected by a congested border, bids of the same direction (e.g. upwards in both LFC areas) are selected, the price targets are restricted so that there can be no counterintuitive flow (i.e. flow from LFC area with high prices to LFC area with low prices). There is one exception to this rule in case of selection of bids of opposite directions (e.g. upwards in LFC area A and downwards LFC area B). In this case, counterintuitive flows are allowed.

An example of this approach is given with Figure 19 and Figure 20.

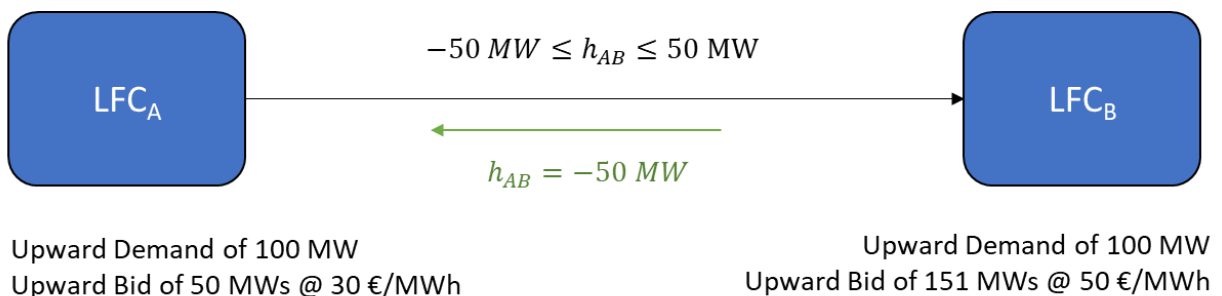

Figure 19: Penalized Prices with selection in the same direction

In this example the CMO optimisation led to the counterintuitive flow from B to A and a congestion on the connecting border as depicted above. The pricing optimisation will determine the final solution with a CBMP of 50€/MWh in both LFC areas. This will provide one price signal to BSP for offering upward bids in LFC area B and in LFC area A reflecting the value of bids from area B that cover the demand in A.

The next example shows the case of selection in opposite direction:

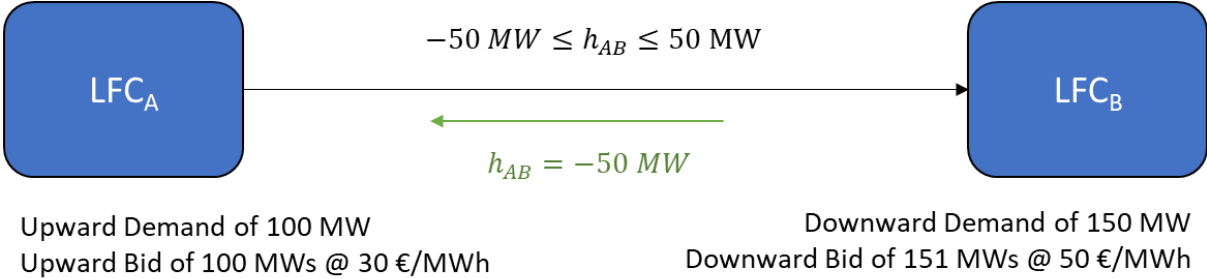

Figure 20: Penalized Prices with selection of opposite direction

In contrast to the example before, in Figure 20 the priority of netting led to the counterintuitive flow from B to A during the flow optimisation and a congestion on the connecting border. The price target of the price preprocessing will set the same price targets as before. Again, energy flows from the high to the low price LFC area which would cause a negative congestion income. But in this case the pricing optimisation will accept the price targets as final solution because the selection is in opposite direction. This will deliver two price signals to BSPs to offer upward bids in LFC area A and downward bids in LFC area B.

5.6 Price Convergence

The difference of prices between two neighboring LFC areas must be equal to zero when the border is unsaturated (“price convergence” for unsaturated borders).

6.0 Appendix

6.1 Mathematical Definitions

OPTIMIZATION VARIABLES

Table 3 gives an overview on the optimisation variables for the optimisation problems.

Variable	Description
$p_{i,j}^+, p_{i,j}^-$	selected volume of upward and downward aFRR bid j in LFC area i
d_i^+, d_i^-	satisfied positive and negative demand in LFC area i
u_i^+, u_i^-	unsatisfied positive and negative demand in LFC area i
ε_{ik}^u	difference of relative deviation from target values for unsatisfied demand of pair of LFC area i and LFC area k .
$d_i^{-,MO}$	negative aFRR demand in LFC area i satisfied by selection of downward aFRR bids (matching offers from the common MOL)
$p_{i,j}^{+,MO}$	activation variable of the upward aFRR bid j in LFC area i matching with downward aFRR bids (counter activation)
$h_b = h_{i \rightarrow k}$	cross-zonal flow on the border b between LFC areas i and k
h_c^{phys}	estimated physical power flow on corridor c
$\varepsilon_{b,d}^h$	difference between absolute cross-zonal flows of border b and border d . $\varepsilon_{b,d}^h = h_b - h_d = h_b^+ + h_b^- - (h_d^+ + h_d^-)$.
∂_b^h	deviation of flow from target flow on border b
∂_c^{phys}	difference of physical flow from target flow on corridor c
$corr_i$	Net position of TSO-TSO interchanges of LFC area i . This value is used as correction for the LFC input. The net position is also called correction value.
∂_i^{corr}	deviation from the target value for imbalance netting of LFC area i .
$\varepsilon_{ik}^{\text{corr}}$	difference of relative deviation from target values for imbalance netting of pair of LFC area i and LFC area k .
r_i	marginal price of LFC area i

Table 3: optimisation variables

Optimisation variables can be superscripted with a sign (e.g. x^+, x^-). Sign-superscripted optimisation variables are always positive (lower-bound to zero) and are used in pairs to separately address positive and negative value ranges: $x = x^+ - x^-$. The absolute value of optimisation variables can consequently be expressed as $x^+ + x^-$.

WEIGHTS AND LIMITS

In the next table the weighting factors are defined:

Variable	Description
f_{sp}	weighting of d_i (demand) in prioritized areas
f_s	weighting of d_i (demand)
f_{ca}	weighting of $d_j^{-,MO}$ (counteractivation)
f_i^+, f_i^-	Either f_{sp} or f_s according to Sec. 2.3
$f_{i,j+}, f_{i,j-}$	price of bid $p_{i,j}^+$ resp. $p_{i,j}^-$
$f_{\varepsilon,u}$	weighting of ε_{ik}^u (equal distribution of unsatisfied demand deviation)
$f_{h,b}$	weighting of h_b (cross-border flow), can be different per border
$f_{\varepsilon,h}$	weighting of ε_{ba}^h (equal distribution of flow)
$f_{\partial,h}$	weighting of ∂_b^h (deviation from target flow)
$f_{phys,c}$	weighting of h_c^{phys} (physical flow), can be different per corridor
f_u	weighting of u (unsatisfied/unnetted demand)
$f_{\partial,phys}$	weighting of ∂_c^{phys} (deviation from target flow)
f_{corr}	weighting of $corr$ (correction values)
$f_{\partial,corr}$	weighting of ∂_i^{corr} (deviation from target value for netting)
$f_{\varepsilon,corr}$	weighting of ε_i^{corr} (equal distribution of netting target deviations)
f_{PT}	weighting of deviation from price target in pricing optimisation
f_{PD}	weighting of price difference on a border in pricing optimisation

Table 4: weighting factors

The next table displays the limits of the optimisation problems.

Variable	Description
$p_{i,j,max}^+$	available aFRR of positive bid j in LFC area i
$p_{i,j,max}^-$	available aFRR of negative bid j in LFC area i
p_i^{demand}	aFRR demand in LFC area i , positive means positive aFRR has to be activated and vice versa
$h_{min,b}, h_{max,b}$	limits for cross-zonal flow on the border; both values are related to the definition of the border as: $h_{min,b} \leq 0$ is the limit in the opposite to the defined direction, $h_{max,b} \geq 0$ is the limit that holds in the direction of the defined border
$h_{min,c}^{phys}, h_{max,c}^{phys}$	limits for the estimated physical power flow on corridor c ; whereas $h_{min,c}^{phys} \leq 0$ and $h_{max,c}^{phys} \geq 0$.
n_{LFC}	number of LFC areas
n_{reg}	number of regions
$n_{b,i}$	number of borders of LFC area i
n_b	total number of borders
n_{phys}	number of corridors defined
$n_{bid,i}^+, n_{bid,i}^-$	number of upward respectively downward aFRR bids in LFC area i
\hat{r}_i	price target of LFC area i

Table 5: limits of the optimisation problems

INDEX SETS

Set	Description
$I := \{1, 2, \dots, n_{LFC}\}$	Set of all LFC areas
$J_i^+ := \{1, 2, \dots, n_{bid,i}^+\}$	Set of all positive bids of LFC area i
$B := \{1, 2, \dots, n_b\}$	Set of all borders
$C := \{1, 2, \dots, n_{phys}\}$	Set of all physical flow corridors

Table 6: definition of sets of variables/indexes

SUBSCRIPTS AND SUPERSSCRIPTS

Subscript resp. Superscript	Description
<i>b</i>	Border
<i>ca</i>	counter activation
<i>corr</i>	correction
<i>LFC</i>	load frequency controller
<i>MO</i>	matching offers
<i>phys</i>	physical (flows over corridors)
<i>reg</i>	Region. Regions are an expression for a set of LFC areas. Regions are structured with different hierarchical levels, beginning with the highest level: synchronous area, sharing region, LFC block, LFC area. A region can consist of one or more LFC areas or subordinate regions.
<i>s</i>	satisfied demand
<i>sp</i>	s... satisfied demand, p ... prioritized LFC area (LFC area that is able to satisfy its own demand)

Table 7: subscripts and superscripts of variables

6.2 Mathematical formulations of objective functions

COMMON MERIT ORDER

The objective function of the CMO optimisation consists of parts with different priorities. Table 8 shows the priority order of the individual objectives. Satisfaction of the aFRR demand of individual LFC areas has the highest priority. Lowest priority has the minimization of the cross-zonal capacity usage and physical flows distribution.

Priority	Objective
1	Maximize satisfaction of the aFRR demand of individual LFC areas
2	Minimization of costs by selecting the cheapest bids
3	Minimize the deviation from the proportional distribution of relative deviation from the target values for unsatisfied demand
4	Minimize the amount of cross-zonal capacity usage
5	Equal distribution of flows over parallel trading paths
6	Minimize approximated physical flows

7	Minimize the deviation of cross-zonal-flows from their target value
8	Minimize the deviation of physical flows from their target value

Table 8: Objectives of the CMO optimisation problem

The weights in the objective function (see table Table 2), reflect the priority of each objective.

The following relation applies among the weights:

$$f_{sp} \gg f_s \gg f_{ca} \gg f_{i,j+}, f_{i,j-} \gg f_{\varepsilon,u} \gg f_{h,b} \gg f_{\varepsilon,h}, f_{phys,c} \gg f_{\partial,h}, f_{\partial,phys}$$

The weighting factor f_{ca} is used in case of limitation and/or blocking of counteractivations. It is defined in chapter 3.6. The factors $f_{\partial,h}, f_{\partial,phys}$ are set to zero.

The weighting factors $f_{i,j+}$ and $f_{i,j-}$ are the prices of upward and downward aFRR bids in the CMOL.

The symbol \gg signifies that there shall be a distance between the weights, which is significantly bigger than the numerical accuracy.

The resulting objective function is displayed in the following:

$$\begin{aligned} \min \left(- \sum_{i=1}^{n_{LFC}} (f_i^+ \cdot d_i^+ + f_i^- \cdot d_i^-) + \sum_{i=1}^{n_{LFC}} \left(\sum_{j=1}^{n_{bid,i}^+} (f_{i,j+} \cdot p_{i,j}^+) - \sum_{j=1}^{n_{bid,i}^-} (f_{i,j-} \cdot p_{i,j}^-) \right) \right. \\ \left. + f_{\varepsilon,u} \sum_{i=1}^{n_{LFC}+n_{reg}} \sum_{k=1}^{n_{LFC}+n_{reg}} (\varepsilon_{ik}^{u,+} + \varepsilon_{ik}^{u,-}) + f_{h,b} \sum_{b=1}^{n_B} (h_b^+ + h_b^-) \right. \\ \left. + f_{\varepsilon,h} \sum_{b=1}^{n_b} \sum_{d=1}^{n_b} (\varepsilon_{b,d}^{h,+} + \varepsilon_{b,d}^{h,-}) + f_{phys,c} \sum_{c=1}^{n_{phys}} (h_c^{phys,+} + h_c^{phys,-}) \right. \\ \left. + f_{\partial,h} \sum_{b=1}^{n_B} (\partial_b^{h,+} + \partial_b^{h,-}) + f_{\partial,phys} \sum_{c=1}^{n_{phys}} (\partial_c^{phys,+} + \partial_c^{phys,-}) \right) \end{aligned}$$

Optimization variables are (see also Table 3):

$$d_i^+, d_i^-, p_{i,j}^+, p_{i,j}^-, \varepsilon_{ik}^{u,+}, \varepsilon_{ik}^{u,-}, h_b^+, h_b^-, \varepsilon_{bd}^{h,+}, \varepsilon_{bd}^{h,-}, \partial_b^{h,+}, \partial_b^{h,-}, h_c^{phys,+}, h_c^{phys,-}, \partial_c^{phys,+}, \partial_c^{phys,-}$$

If counter-activation shall be avoided (see Chapter 2.6), the selection of upward bids for the matching of downward offers has to be minimized, as well as the demand satisfied by activation of offers. Hence, the following term has to be added to the objective function:

$$f_{ca} \left(\sum_{i \in I} \sum_{j \in J_i^+} p_{i,j}^{+,MO} + \sum_{i \in I} (d_i^{-,MO}) \right)$$

Due to symmetry it is not necessary to minimize $p_{i,j}^{-,MO}$ and $d_i^{+,MO}$, therefore they are not defined.

By convention, all variables with sign superscripts (x^+, x^-) are defined to be positive, so their lower-bound is zero:

$$x^+ \geq 0, x^- \geq 0$$

IMBALANCE NETTING

The objective function of the IN consists of nine parts with different priorities. The priority order of the individual objectives is like the following:

Priority	Objective
1	Minimize the deviation from the target value of netting
2	Minimize unsatisfied aFRR demand of individual LFC areas
3	Minimize the deviation from the proportional distribution of deviation from the target value of netting
4	Minimize the absolute value of the correction values
5	Minimize the amount of cross-zonal capacity usage
6	Equal distribution of flows over parallel trading paths
7	Minimize approximated physical flows
8	Minimize the deviation of cross-zonal-flows from their target value (optional)
9	Minimize the deviation of physical flows from their target value (optional)

Table 9: Objectives of the IN optimisation problem

The objective function is displayed in the following:

$$\begin{aligned}
 \min \left(& f_{\partial,corr} \sum_{i \in I} (\partial_i^{corr,+} + \partial_i^{corr,-}) + f_{\varepsilon,corr} \sum_{i \in I} \sum_{k \in I, k \neq i} (\varepsilon_{ik}^{corr,+} + \varepsilon_{ik}^{corr,-}) + f_u \sum_{i \in I} (u_i^+ + u_i^-) \right. \\
 & + f_{corr} \sum_{i \in I} (corr_i^+ + corr_i^-) + f_{h,b} \sum_{b \in B} (h_b^+ + h_b^-) + f_{\varepsilon,h} \sum_{b \in B} \sum_{d \in B, d \neq b} (\varepsilon_{b,d}^{h,+} + \varepsilon_{b,d}^{h,-}) \\
 & + f_{phys,c} \sum_{c \in C} (h_c^{phys+} + h_c^{phys-}) + f_{\partial,h} \sum_{b \in B} (\partial_b^{h+} + \partial_b^{h-}) \\
 & \left. + f_{\partial,phys} \sum_{c \in C} (\partial_c^{phys+} + \partial_c^{phys-}) \right)
 \end{aligned}$$

The optimization variables are (see also Table 3)

$$corr_i^+, corr_i^-, u_i^+, u_i^-, \partial_b^{corr,+}, \partial_b^{corr,-}, \varepsilon_{ik}^{corr,+}, \varepsilon_{ik}^{corr,-}, h_b^+, h_b^-, \varepsilon_{b,d}^{h,+}, \varepsilon_{b,d}^{h,-}, \partial_b^{h+}, \partial_b^{h-},$$

$$h_c^{phys,+}, h_c^{phys,-}, \partial_c^{phys,+}, \partial_c^{phys,-}$$

The following relation applies between the weights:

$$f_{\partial,c} \gg f_u \gg f_{\varepsilon,corr} \gg f_{corr} \gg f_{h,b} \gg f_{\varepsilon,h} \gg f_{phys,c} \gg f_{\partial,h}, f_{\partial,phys}$$

As mentioned in the introduction the factors $f_{\partial,h}, f_{\partial,phys}$ are set to zero.

PRICE OPTIMIZATION

Priority	Objective
1	Minimize deviation to price target for each LFC area (quadratic, squared deviation)
2	Minimize price differences on each border (quadratic, squared difference)

Table 10: Objectives of the pricing optimisation problem

The objective function is displayed in the following:

$$\min \left(f_{PT} \cdot \sum_{i \in I} (\hat{r}_i - r_i)^2 + f_{PD} \cdot \sum_{i \in I} \sum_{k \in I: \exists h_{k \rightarrow i} \in B} (r_i - r_k)^2 \right)$$

The following relation applies between the weights:

$$f_{PT} \gg f_{PD}$$